

Overview

The KEMET LF metal box filters cover single-phase or three-phase requirements with a wide variety of characteristics. These filters are optimized for conduction noise. Their input/output terminals are screw type or lead wire type.

Applications

- Industrial equipment
- Machine tool
- Inverters

Benefits

- Single-phase or three-phase 250 VAC
- Current range from 2 to 60 A
- Operating temperature range from -25°C to +55°C (with some exceptions at -20°C to 45°C and -20°C to +55°C)
- UL approved versions available
- RoHS compliant



Part Number System

LF-	2	02	U		-1
Series	Phase	Rated Current (A)	Approval	Specification	Internal Management Code
LF	2 = Single-phase 3 = Three-phase	0x = 0x A xx = xx A	Blank = No approvals U = UL approved Note: With exceptions, see Table 1 for details	Blank = Standard N = Double common choke P = Hi pot 2,000 V for single-phase	-F -1 -9

Алматы (7273)495-231
Ангарск (3955)60-70-56
Архангельск (8182)63-90-72
Астрахань (8512)99-46-04
Барнаул (3852)73-04-60
Белгород (4722)40-23-64
Благовещенск (4162)22-76-07
Брянск (4832)59-03-52
Владивосток (423)249-28-31
Владикавказ (8672)28-90-48
Владимир (4922)49-43-18
Волгоград (844)278-03-48
Вологда (8172)26-41-59
Воронеж (473)204-51-73
Екатеринбург (343)384-55-89

Россия +7(495)268-04-70

Иваново (4932)77-34-06
Ижевск (3412)26-03-58
Иркутск (395)279-98-46
Казань (843)206-01-48
Калининград (4012)72-03-81
Калуга (4842)92-23-67
Кемерово (3842)65-04-62
Киров (8332)68-02-04
Коломна (4966)23-41-49
Кострома (4942)77-07-48
Краснодар (861)203-40-90
Красноярск (391)204-63-61
Курск (4712)77-13-04
Курган (3522)50-90-47
Липецк (4742)52-20-81

Казахстан +7(7172)727-132

Магнитогорск (3519)55-03-13
Москва (495)268-04-70
Мурманск (8152)59-64-93
Набережные Челны (8552)20-53-41
Нижний Новгород (831)429-08-12
Новокузнецк (3843)20-46-81
Новосибирск (383)227-86-73
Омск (3812)21-46-40
Орел (4862)44-53-42
Оренбург (3532)37-68-04
Пенза (8412)22-31-16
Петрозаводск (8142)55-98-37
Псков (8112)59-10-37
Пермь (342)205-81-47

Киргизия +996(312)96-26-47

Ростов-на-Дону (863)308-18-15
Рязань (4912)46-61-64
Самара (846)206-03-16
Саранск (8342)22-96-24
Санкт-Петербург (812)309-46-40
Саратов (845)249-38-78
Севастополь (8692)22-31-93
Симферополь (3652)67-13-56
Смоленск (4812)29-41-54
Сочи (862)225-72-31
Ставрополь (8652)20-65-13
Сургут (3462)77-98-35
Сыктывкар (8212)25-95-17
Тамбов (4752)50-40-97
Тверь (4822)63-31-35

Тольятти (8482)63-91-07
Томск (3822)98-41-53
Тула (4872)33-79-87
Тюмень (3452)66-21-18
Ульяновск (8422)24-23-59
Улан-Удэ (3012)59-97-51
Уфа (347)229-48-12
Хабаровск (4212)92-98-04
Чебоксары (8352)28-53-07
Челябинск (351)202-03-61
Череповец (8202)49-02-64
Чита (3022)38-34-83
Якутск (4112)23-90-97
Ярославль (4852)69-52-93

Dimensions - Millimeters

LF-202U-1

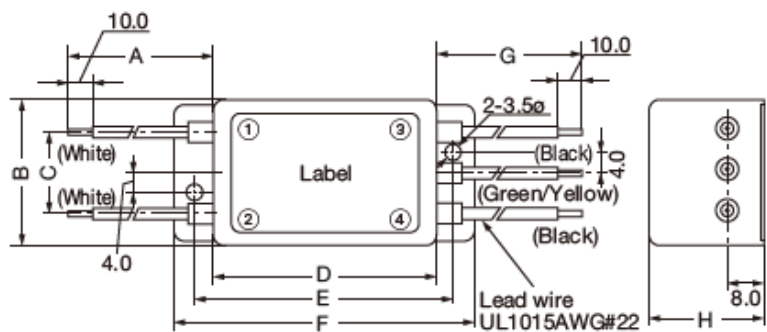

A	B	C	D	E	F	G	H
200	32	17	48	56	64	200	25

LF-202-9

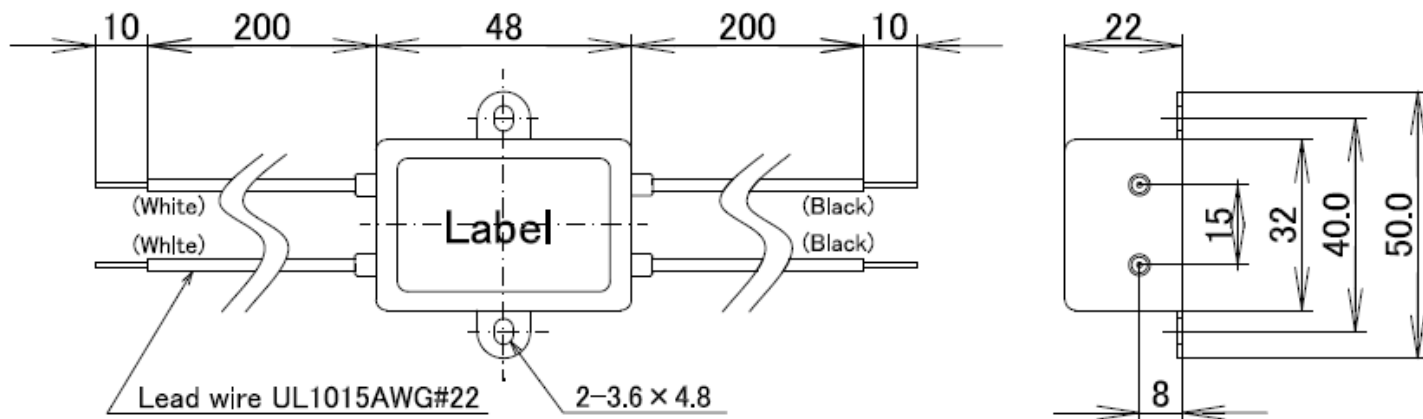

Dimensions - Millimeters cont.

LF-210, LF-210N, LF-215N

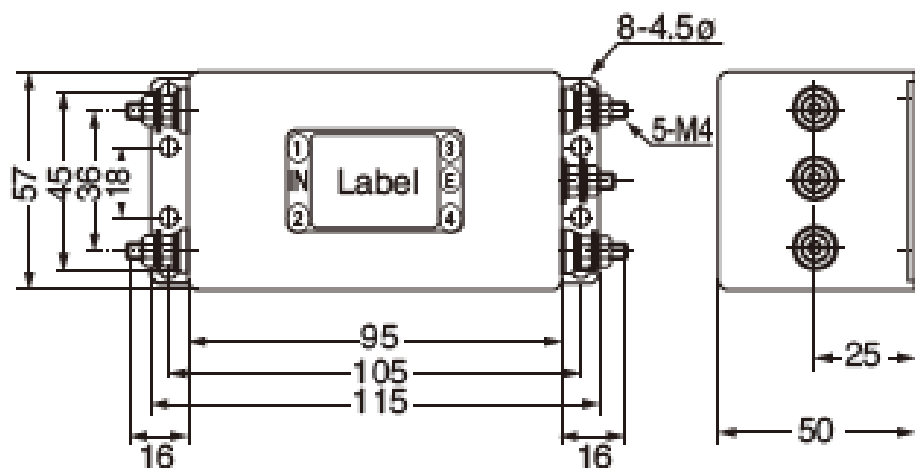

Recommended torque (N-m) maximum

- Line terminal (M4: 0.78)
- Earth terminal (M4: 1.18)

LF-215F, LF-215U

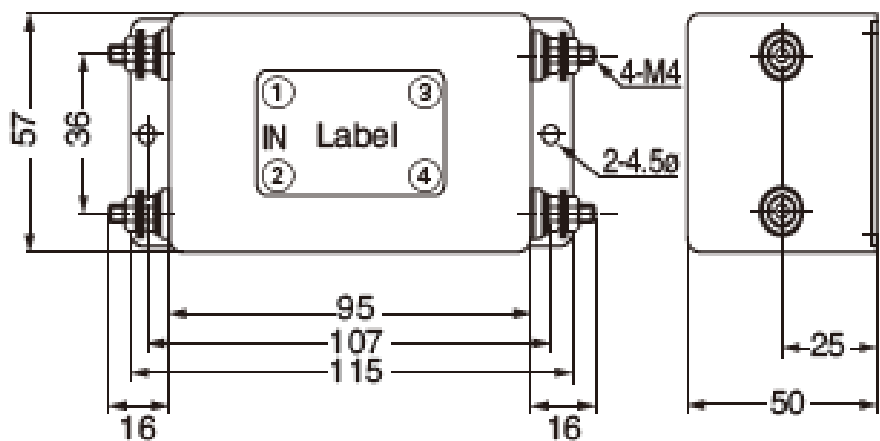

Recommended torque (N-m) maximum

- Line terminal (M4: 0.78)

Dimensions – Millimeters cont.

LF-220N, LF-230N

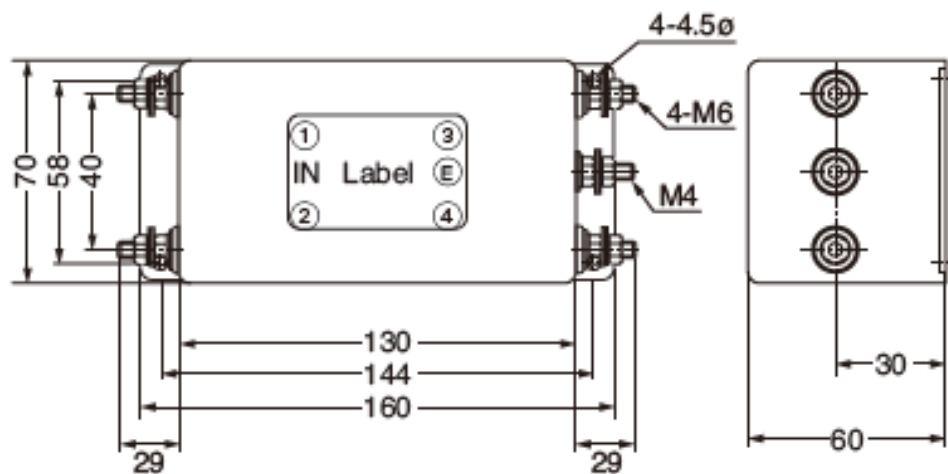

Recommended torque (N-m) maximum

- Line terminal (M6: 1.18)
- Earth terminal (M4: 1.18)

LF-240, LF-240P, LF-250, LF-250P

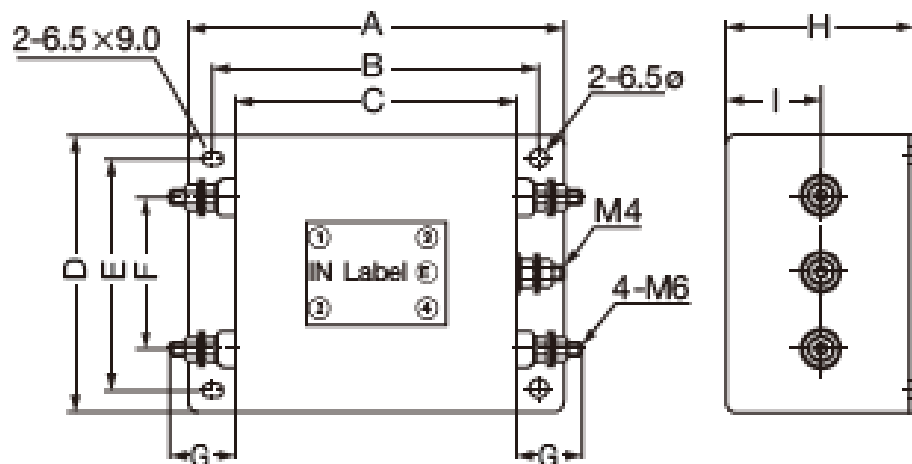

Recommended torque (N-m) maximum

- Line terminal (M6: 1.18)
- Earth terminal (M4: 1.18)

Part Number	A	B	C	D	E	F	G	H	I
LF-240	210	190	170	120	100	60	29	75	40
LF-240P									
LF-250	240	220	200	90	70	40	30	80	40
LF-250P									

Environmental Compliance

KEMET LF EMI-RFI Filters comply with EU RoHS Directive 2011/65/EU and (EU) 2015/863. Products that fall under the exemptions listed in below table are also included.



Part Number	RoHS Compliant	RoHS Exemption Code
LF-202U-1	Yes	No
LF-202-9	Yes	No
LF-210	Yes	6(c)
LF-210N	Yes	6(c) and 7(c)-I
LF-215N	Yes	6(c) and 7(c)-I
LF-215F	Yes	6(c)
LF-215U	Yes	6(c)
LF-220N	Yes	6(c) and 7(c)-I
LF-230N	Yes	6(c) and 7(c)-I
LF-240	Yes	6(c)
LF-240P	Yes	6(c)
LF-250	Yes	6(c)
LF-250P	Yes	6(c)
LF-260N	Yes	6(c) and 7(c)-I
LF-305	Yes	6(c)
LF-310	Yes	6(c)
LF-315	Yes	6(c)
LF-320	Yes	6(c)
LF-330	Yes	6(c)
LF-340	Yes	6(c)

Code	Exemption
6(c)	Copper alloy containing up to 4% lead by weight
7(c)-I	Electrical and electronic components containing lead in a glass or ceramic other than dielectric ceramic in capacitors, e.g. piezoelectronic devices, or in a glass or ceramic matrix compound

Approvals

Certification Body	File Number	Part Number
UL	E59551	LF-202U-1, LF-210, LF-215U and LF-310

Performance Characteristics

Item	Performance Characteristics
Rated Voltage	250 V
Rated Current Range	2 – 60 A
Withstanding Voltage	1,500 VAC (1 minute, line to ground) except LF-xxxP: 2,000 VAC (1 minute, line to ground)
Insulation Resistance	300 M Ω minimum at 500 VDC (1 minute, line to ground)
Leakage Current Range	0.005 – 1.000 mA maximum at 250 V/60 Hz
Input/Output Terminal Type	Screw and Lead Wire
Operating Temperature Range	-25°C to +55°C (not including self temperature rise) (with some exceptions at -20°C to 45°C and -20°C to +55°C)

Table 1 – Ratings & Part Number Reference

Part Number	Phase	Rated Voltage AC (V)	Rated Current AC (A)	DC Available	Leakage Current at 250 V/60 Hz (mA) Maximum	Temperature Rise (K) Maximum	Operating Temperature Range	Terminal Type	Approval	Weight (g)
LF-202U-1	Single-phase	250	2	Yes	1.000	30	-20°C to +55°C	Lead wire	UL	95
LF-202-9	Single-phase	250	2	Yes	0.005	30	-25°C to +55°C	Lead wire		50
LF-210	Single-phase	250	10	Yes	1.000	30	-20°C to +55°C	Screw	UL	590
LF-210N	Single-phase	250	10	Yes	1.000	30	-20°C to +55°C	Screw		650
LF-215N	Single-phase	250	15	Yes	1.000	30	-20°C to +55°C	Screw		650
LF-215F	Single-phase	250	15	Yes	1.000	30	-20°C to +55°C	Screw		650
LF-215U	Single-phase	250	15	Yes	1.000	30	-20°C to +55°C	Screw	UL	620
LF-220N	Single-phase	250	20	Yes	1.000	30	-20°C to +55°C	Screw		1,200
LF-230N	Single-phase	250	30	Yes	1.000	30	-20°C to +55°C	Screw		1,200
LF-240	Single-phase	250	40	Yes	1.000	40	-20°C to +45°C	Screw		3,200
LF-240P	Single-phase	250	40	Yes	1.000	40	-20°C to +45°C	Screw		3,200
LF-250	Single-phase	250	50	Yes	1.000	40	-20°C to +45°C	Screw		4,000
LF-250P	Single-phase	250	50	Yes	1.000	40	-20°C to +45°C	Screw		4,000
LF-260N	Single-phase	250	60	Yes	1.000	30	-20°C to +55°C	Screw		6,500
LF-305	Three-phase	250	5	No	1.000	30	-20°C to +55°C	Screw		650
LF-310	Three-phase	250	10	No	1.000	30	-20°C to +55°C	Screw	UL	1,900
LF-315	Three-phase	250	15	No	1.000	30	-20°C to +55°C	Screw		1,900
LF-320	Three-phase	250	20	No	1.000	30	-20°C to +55°C	Screw		2,300
LF-330	Three-phase	250	30	No	1.000	30	-20°C to +55°C	Screw		2,400
LF-340	Three-phase	250	40	No	1.000	40	-20°C to +45°C	Screw		5,300

Circuit Diagram

LF-202U-1

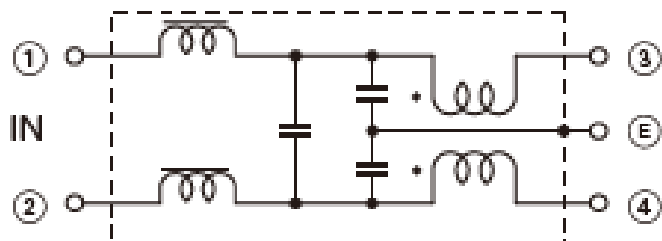

LF-202-9

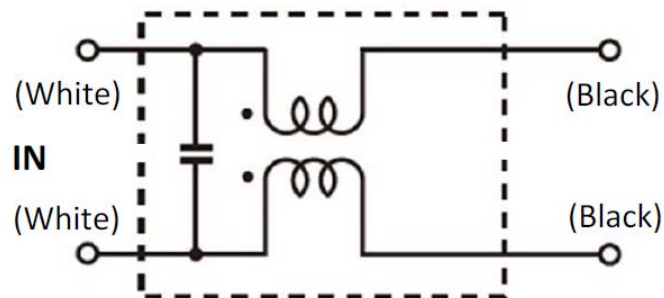

LF-210

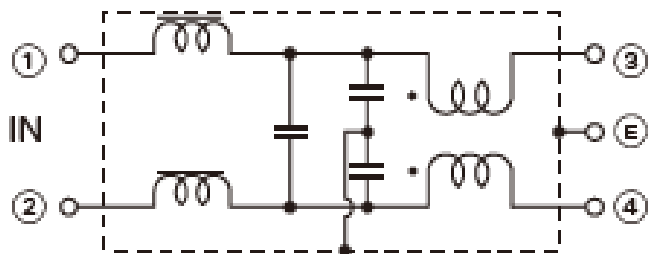

LF-210N, LF-215N, LF-220N, LF-230N

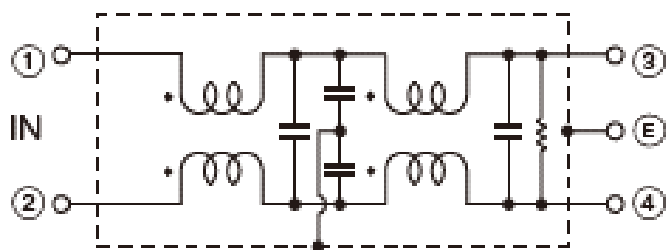

Circuit Diagram cont.

LF-215F, LF-215U

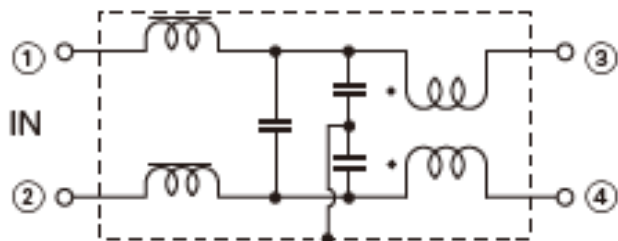

LF-240, LF-240P, LF-250, LF-250P

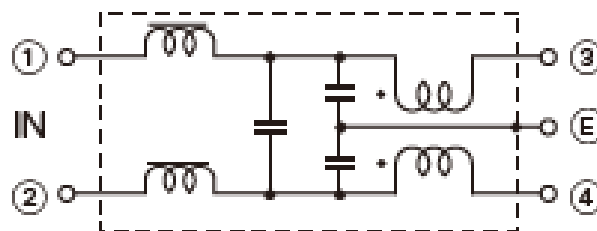

LF-260N

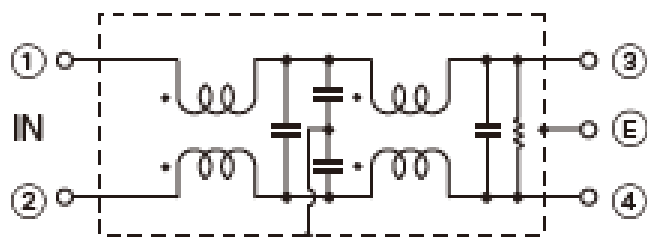

LF-305, LF-310, LF-315, LF-320, LF-330, LF-340

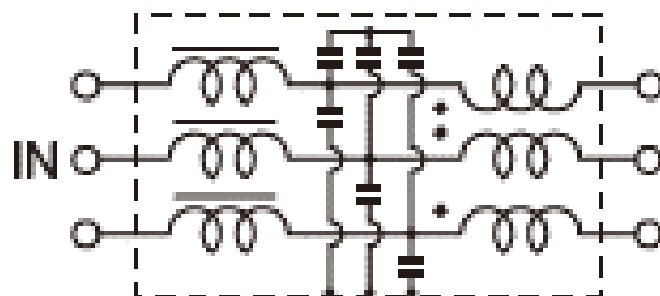

Measuring Circuit - Common Mode

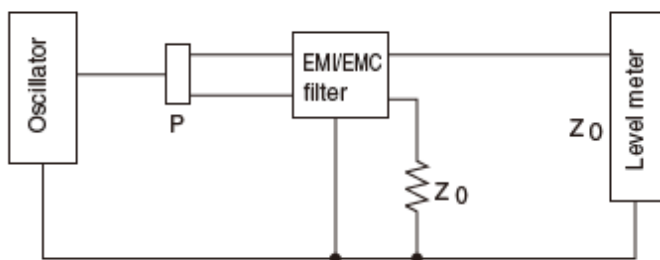

P: Power divider Z_0 : 50Ω

Attenuation (Static Characteristics)

LF-202U-1

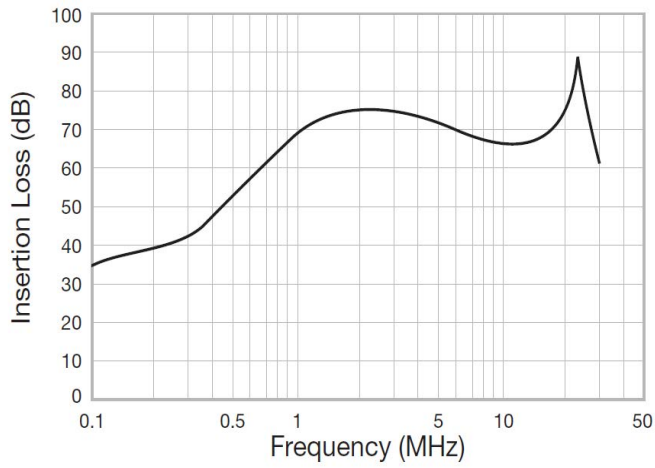

LF-202-9

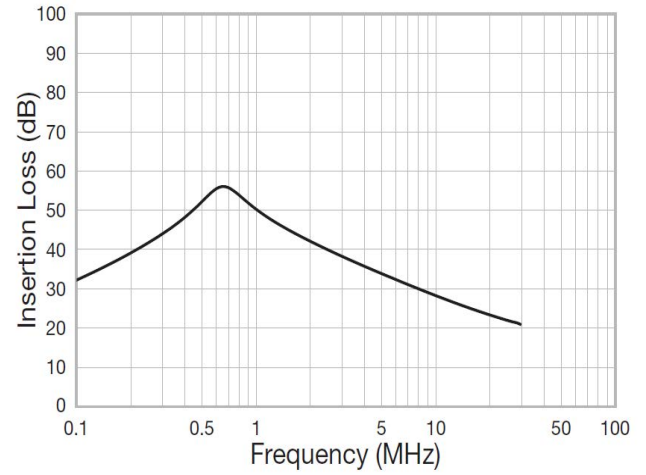

LF-210

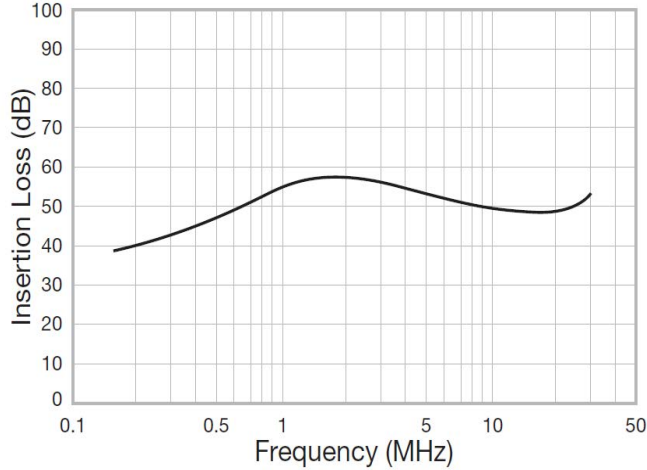

LF-210N

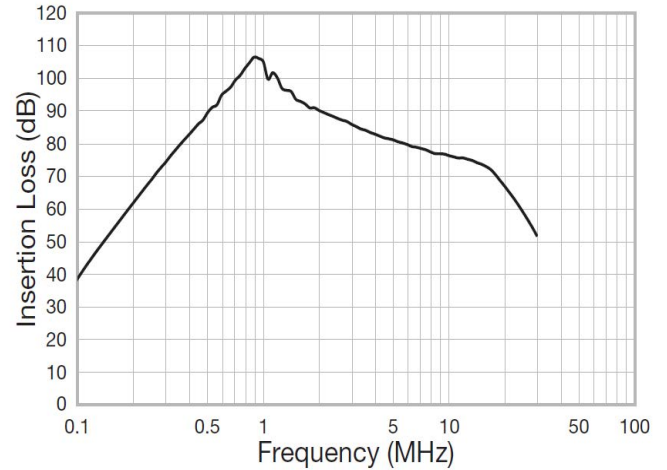

LN-215F, LF-215U

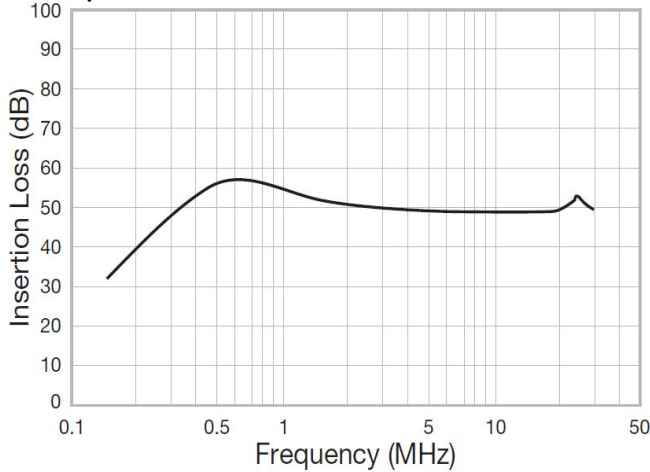

LF-215N

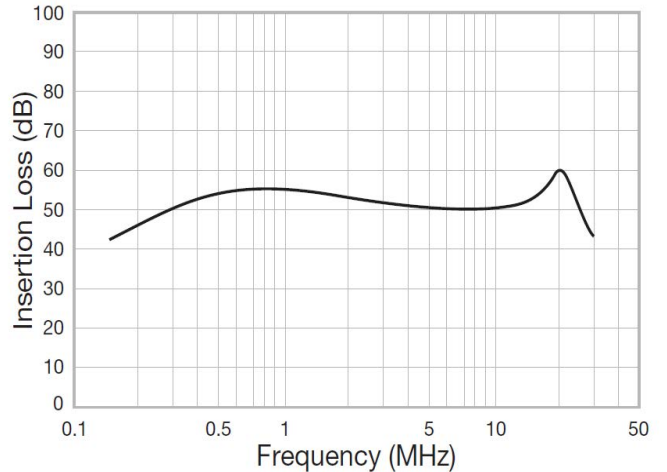

Attenuation (Static Characteristics) cont.

LF-220N

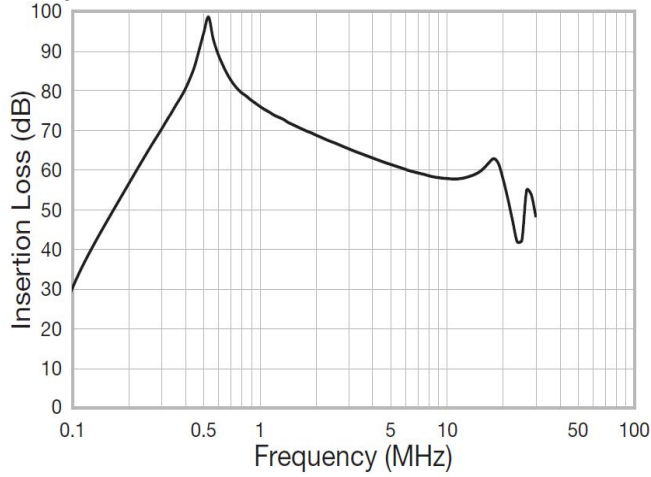

LF-230N

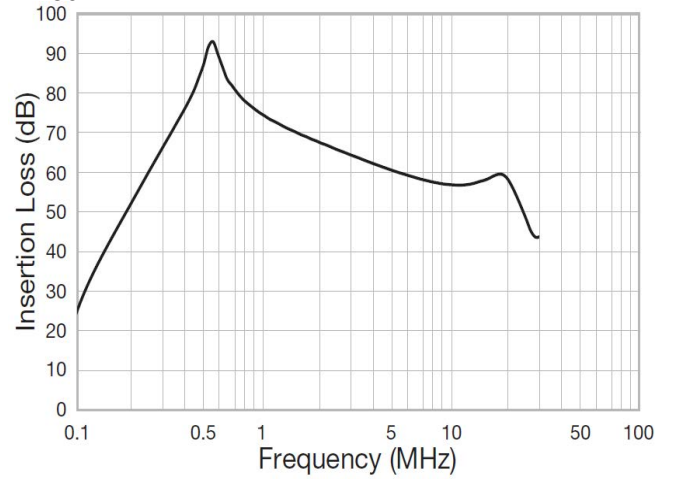

LF-240, LF-240P

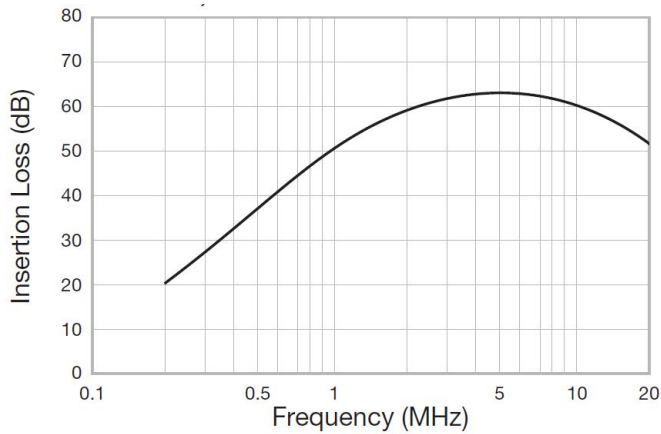

LF-250, LF-250P

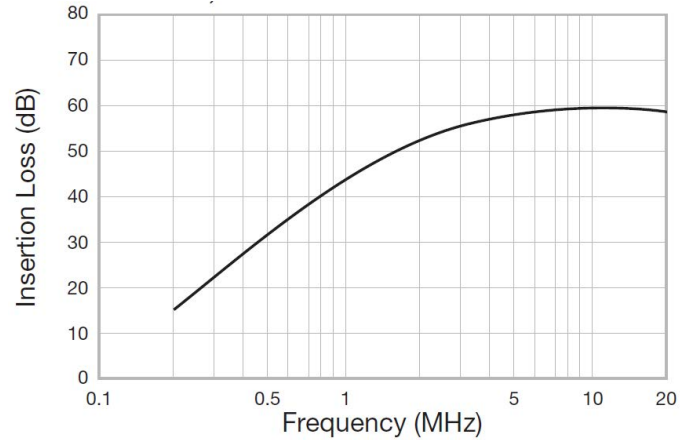

LF-260N

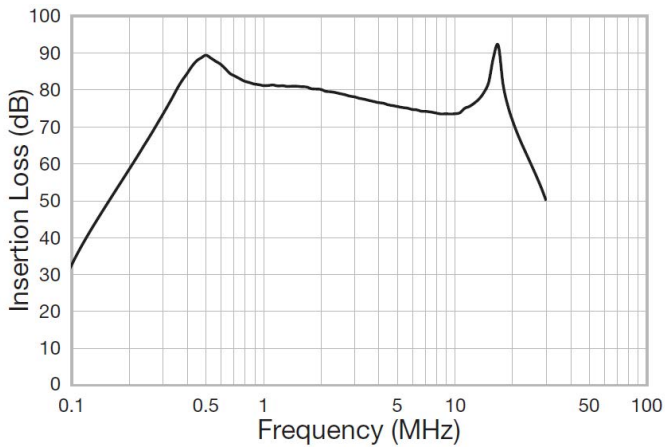

LF-305

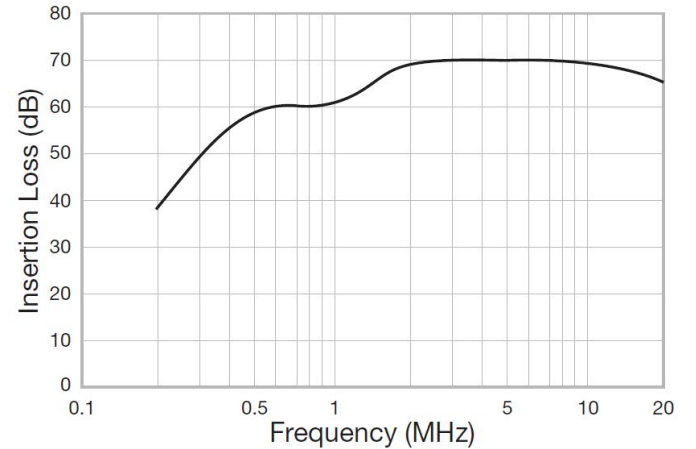

Attenuation (Static Characteristics) cont.

LF-310

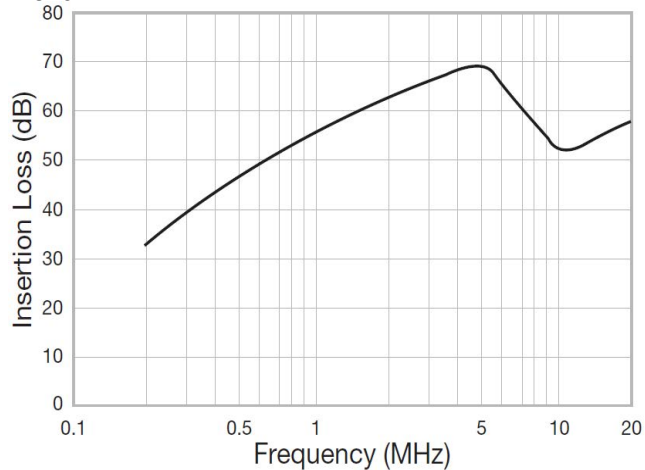

LF-315

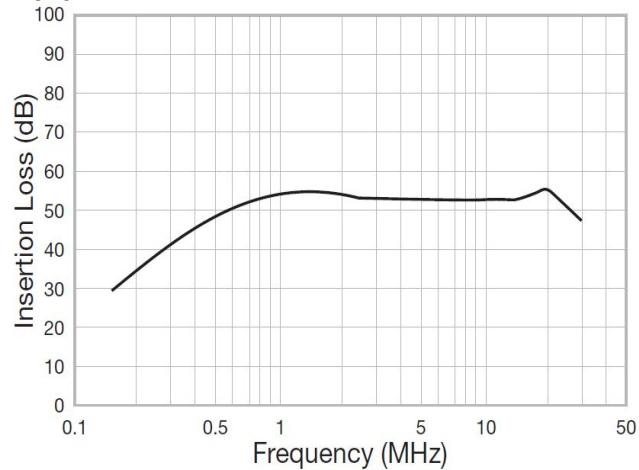

LF-320

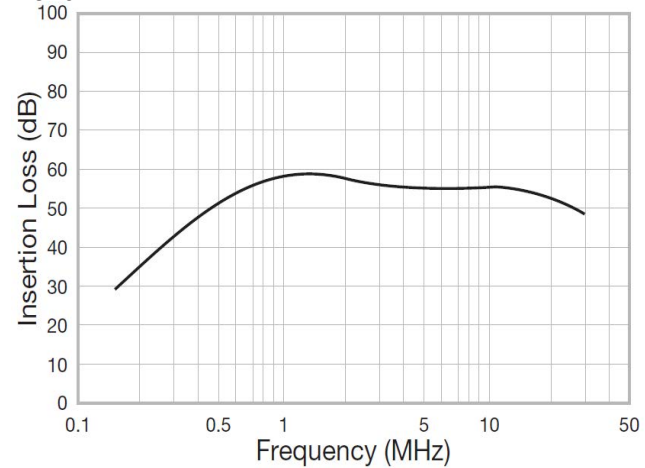

LF-330

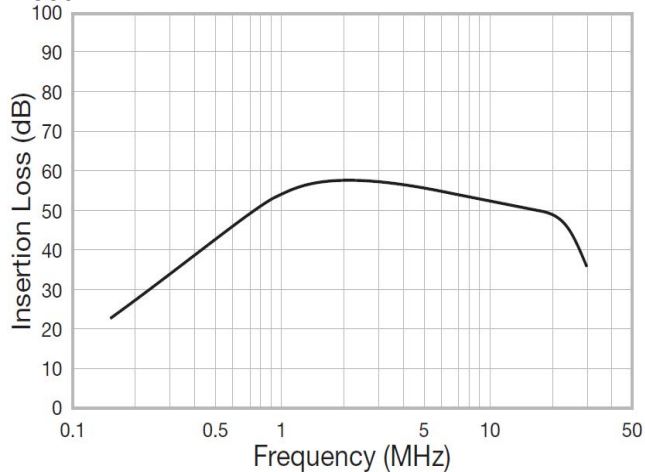

LF-340

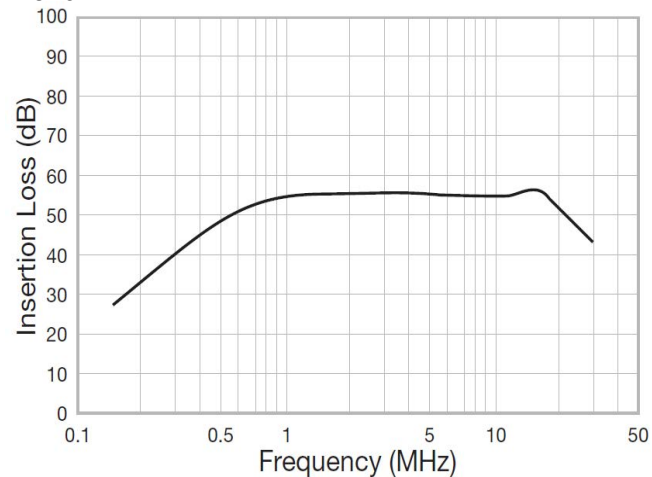

Packaging

Part Type	Packaging Type	Pieces per Box
LF-202U-1	Tray	10
LF-202-9		
LF-210		
LF-210N		15
LF-215N		
LF-215F		5
LF-215U		15
LF-220N		
LF-230N		12
LF-240		
LF-240P		5
LF-250		
LF-250P		
LF-260N		2
LF-305		16
LF-310		
LF-315		
LF-320		7
LF-330		
LF-340		3

Handling Precautions

Precautions for product storage

EMI-RFI Filters should be stored in normal working environments. While the filters themselves are quite robust in other environments, solderability will be degraded by exposure to high temperatures, high humidity, corrosive atmospheres, and long term storage.

KEMET recommends that maximum storage temperature not exceed 40°C and maximum storage humidity not exceed 70% relative humidity and atmospheres should be free of chlorine and sulfur bearing compounds. Temperature fluctuations should be minimized to avoid condensation on the parts. Also, avoid storage near strong magnetic fields as this might magnetize the product.

For the parts LF-202U-1 and LF-202-9, for optimized solderability on their lead wires, their stock should be used promptly, preferably within 6 months of receipt. For the other parts, having screw terminals, their stock should be used preferably within 12 months of receipt.

Алматы (7273)495-231
 Ангарск (3955)60-70-56
 Архангельск (8182)63-90-72
 Астрахань (8512)99-46-04
 Барнаул (3852)73-04-60
 Белгород (4722)40-23-64
 Благовещенск (4162)22-76-07
 Брянск (4832)59-03-52
 Владивосток (423)249-28-31
 Владикавказ (8672)28-90-48
 Владимир (4922)49-43-18
 Волгоград (844)278-03-48
 Вологда (8172)26-41-59
 Воронеж (473)204-51-73
 Екатеринбург (343)384-55-89
 Россия +7(495)268-04-70

Иваново (4932)77-34-06
 Ижевск (3412)26-03-58
 Иркутск (395)279-98-46
 Казань (843)206-01-48
 Калининград (4012)72-03-81
 Калуга (4842)92-23-67
 Кемерово (3842)65-04-62
 Киров (8332)68-02-04
 Коломна (4966)23-41-49
 Кострома (4942)77-07-48
 Краснодар (861)203-40-90
 Красноярск (391)204-63-61
 Курск (4712)77-13-04
 Курган (3522)50-90-47
 Липецк (4742)52-20-81
 Казахстан +7(7172)727-132

Магнитогорск (3519)55-03-13
 Москва (495)268-04-70
 Мурманск (8152)59-64-93
 Набережные Челны (8552)20-53-41
 Нижний Новгород (831)429-08-12
 Новокузнецк (3843)20-46-81
 Ноябрьск (3496)41-32-12
 Новосибирск (383)227-86-73
 Омск (3812)21-46-40
 Орел (4862)44-53-42
 Оренбург (3532)37-68-04
 Пенза (8412)22-31-16
 Петрозаводск (8142)55-98-37
 Псков (8112)59-10-37
 Пермь (342)205-81-47
 Киргизия +996(312)96-26-47

Ростов-на-Дону (863)308-18-15
 Рязань (4912)46-61-64
 Самара (846)206-03-16
 Саранск (8342)22-96-24
 Санкт-Петербург (812)309-46-40
 Саратов (845)249-38-78
 Севастополь (8692)22-31-93
 Симферополь (3652)67-13-56
 Смоленск (4812)29-41-54
 Сочи (862)225-72-31
 Ставрополь (8652)20-65-13
 Сургут (3462)77-98-35
 Сыктывкар (8212)25-95-17
 Тамбов (4752)50-40-97
 Тверь (4822)63-31-35

Тольятти (8482)63-91-07
 Томск (3822)98-41-53
 Тула (4872)33-79-87
 Тюмень (3452)66-21-18
 Ульяновск (8422)24-23-59
 Улан-Удэ (3012)59-97-51
 Уфа (347)229-48-12
 Хабаровск (4212)92-98-04
 Чебоксары (8352)28-53-07
 Челябинск (351)202-03-61
 Череповец (8202)49-02-64
 Чита (3022)38-34-83
 Якутск (4112)23-90-97
 Ярославль (4852)69-52-93